

SKY SOLO

DESCRIPTION

The Sky Collection was inspired as a modular pendant lighting system and Sky Solo is its core foundational element. Its minimal all-aluminum design highlights a powerful two-sided flat panel light source with Dim to Warm LED technology that can deliver up to 1250 lumens of warm ambient light in all directions. Sky Solo can be suspended individually, in series, or as striking chandelier groupings for residential, contract, and hospitality settings alike. Solo's light element can also be combined with a wide range of premium shade reflectors in metal, wood and acoustic felt to provide an extraordinary breadth of performance and decorative solutions.

FIXTURE TYPE

Pendant

LIGHT SOURCE

LED Flat-Panel downlight/High-output LED array uplight

PRODUCT CODES

Sky Solo SKY SOLO

LIGHT CONTROL

Hard-wired, dimmable

Compatible with TRIAC/ELV dimmers.

(0-10V available with 277V driver option)

FEATURES

Dim-to-Warm (DTW) Light Source

Fully dimmable

Uplight/downlight

Energy-efficient, flat panel technology

Glare-free illumination

SPECIFICATIONS

Voltage : 120V 50/60Hz

(100-277V 50/60Hz Available upon request)

Power Consumption : 18W MAX

Color Temperature : 2700K-2200K DTW

Luminosity : 1250 Lumens total (850 down/400 up)

Luminaire Efficacy : 70 Lumens/Watt

Color Rendition Index : 90 CRI

50K hour lifespan

Cable length : 10' (305cm)(Field cuttable)

1 year warranty

CERTIFICATIONS

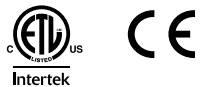

PACKAGING WEIGHT AND DIMENSIONS

Sky Solo lamp 3.1LBS 19" X 10.2" X 24"

1.4KGS 48cm X 26cm X 6cm

NOTES

Custom requests can be considered on volume orders



FINISHES



POLISHED ALUMINUM

DIMENSIONS

SKY SOLO

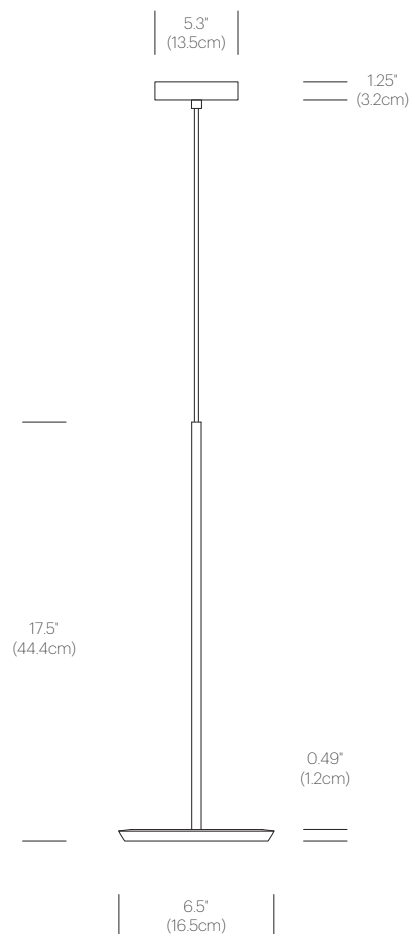

SKY SOLO CHANDELIER

DESCRIPTION

The Sky Collection was inspired as a modular pendant lighting system and Sky Solo is its core foundational element. Its minimal all-aluminum design highlights a powerful two-sided flat panel light source with Dim to Warm LED technology that can deliver up to 1250 lumens of warm ambient light in all directions. Sky Solo can be suspended individually, in series, or as striking chandelier groupings for residential, contract, and hospitality settings alike. Solo's light element can also be combined with a wide range of premium shade reflectors in metal, wood and acoustic felt to provide an extraordinary breadth of performance and decorative solutions.

FIXTURE TYPE

Pendant

LIGHT SOURCE

LED Flat-Panel downlight/High-output LED array uplight

PRODUCT CODES

Sky Solo SKY SOLO

LIGHT CONTROL

Hard-wired, dimmable

Compatible with TRIAC/ELV dimmers.

(0-10V available with 240/277V driver option)

FEATURES

Dim-to-Warm (DTW) Light Source

Fully dimmable

Uplight/downlight

Energy-efficient, flat panel technology

Glare-free illumination

SPECIFICATIONS

Voltage : 120V 50/60Hz

(100-277V 50/60Hz Available upon request)

Power Consumption : 18W MAX

Color Temperature : 2700K-2200K DTW

Luminosity : 1250 Lu total (850 down/400 up)

Luminaire Efficacy : 70 Lumens/Watt

Color Rendition Index : 90 CRI

50K hour lifespan

Cable length : 10' (305cm)(Field cuttable)

1 year warranty

CERTIFICATIONS



Intertek

PACKAGING WEIGHT AND DIMENSIONS

Sky Solo lamp	3.1LBS	19" X 10.2" X 2.4"
	1.4KGS	48cm X 26cm X 6cm
Chandelier canopy 17":	15LBS	22" X 22" X 6"
	6.8KGS	56cm X 56cm X 15cm
Chandelier canopy 26":	30LBS	32" X 32" X 6"
	13.6KGS	81cm X 81cm X 15cm

NOTES

Custom requests can be considered on volume orders

Pablo

FINISHES

SKY LAMP



WHITE/
WHITE/
WHITE CABLE

CIELO CANOPY



WHITE

DIMENSIONS

SKY CHANDELIER 3

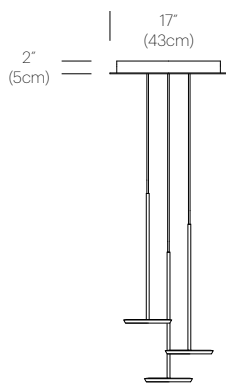

SKY CHANDELIER 5

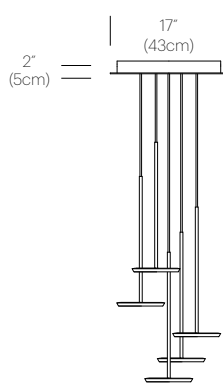

SKY CHANDELIER 7

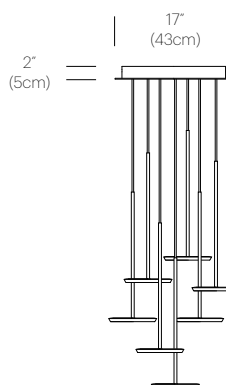

SKY CHANDELIER 13

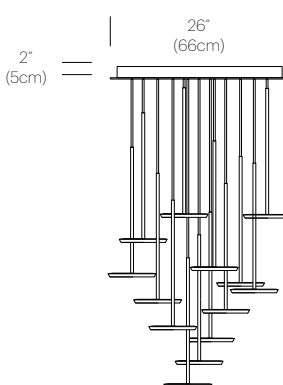

CIELO CHANDELIER CANOPY 3, 5, 7

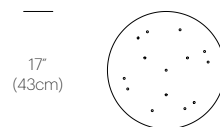

CIELO CHANDELIER CANOPY 13

